

INSTALLATION

1. Open all bags and group parts together as upper and lower assemblies as shown in the diagrams.

UPPER MOUNT

2. Use a padded surface or some other fixture to support the Street Shield EX. Starting from the ball end of the rod, slide a socket boot over each upright. Support windshield on a non abrasive surface and push upright into each upper socket as shown. Do both sides. Figure 1.

NOTE: If the windshield is colder than 65° F (18°C), WARM the socket points with a hair dryer.

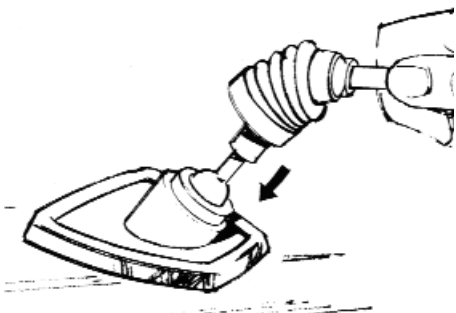
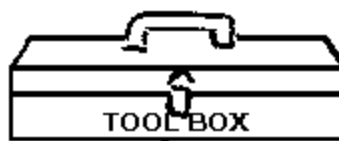
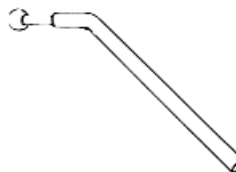
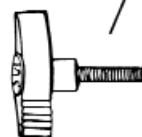

Figure 1



Flat Blade Screwdriver
Adjustable Wrench
Hex Key (supplied in kit)

LOWER BRACKET 34-345000 2

37-400640 CLAMP 2

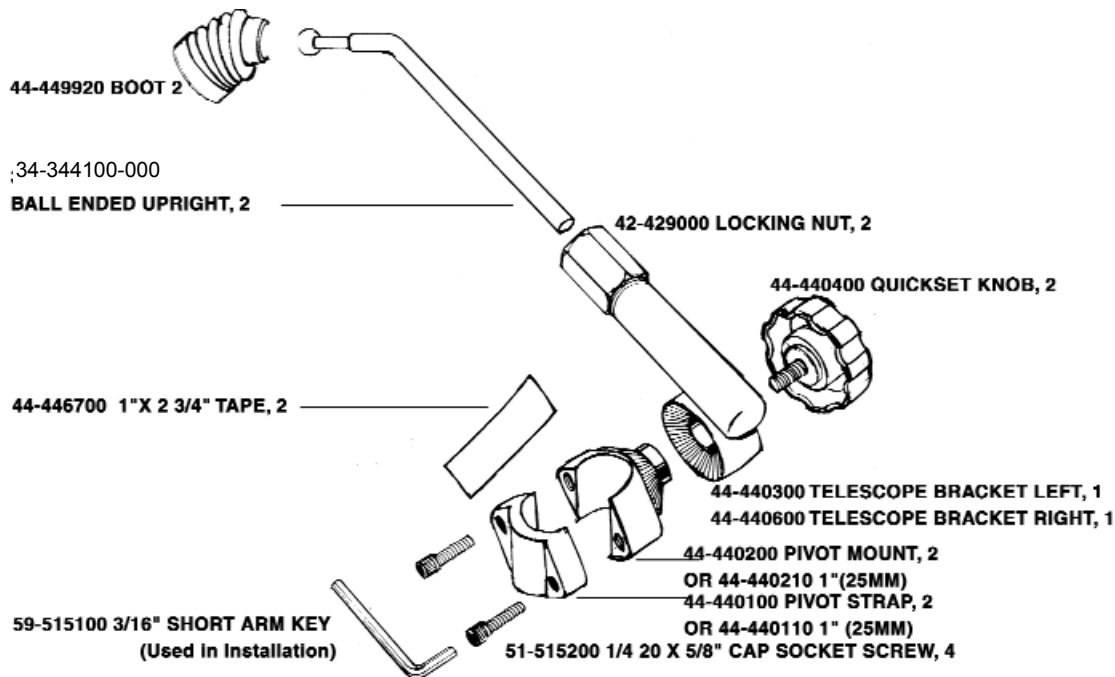
44-449520 WING SCREW 2

44-449420 FORK BOSS 2

44-449320 WRAP AROUND CLAMP 2 (SHOWN FOLDED)

3. Repeat procedure for lower rod. The lower rods do not have boots.

DETERMINE POSITION OF WINDSHIELD ON MOTORCYCLE

4. Position the windshield from 1/2" (1cm) to 3" (7.5cm) above the headlight depending on the best location.

INSTALL TELESCOPE BRACKETS

5. **Loosely** thread locking nuts onto telescope brackets. Slide the appropriate left and right telescope bracket onto the upright. Figure 2.

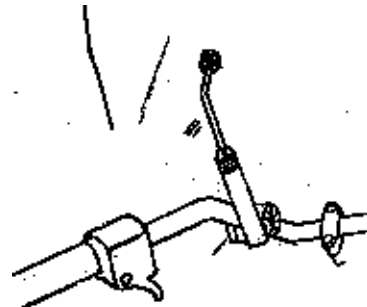

Figure 2.

IN SOME CASES, SUCH AS THE ZR1100 AND VF750, IN ORDER TO CLEAR THE MASTER CYLINDER OR OTHER OBSTRUCTIONS ON THE HANDLEBARS, YOU WILL NEED TO REVERSE THE POSITION OF THE TELESCOPE RACKETS.

DETERMINE LOCATION OF THE HANDLEBAR PIVOT MOUNT AND LOWER FORK BOSS

6. Hold windshield to motorcycle and determine where to locate pivot mounts by positioning the telescope brackets to the handlebars. Try to achieve as closely as possible: Figure 3.

A. Minimize upright extension from telescope bracket. Slide handlebar pivot assembly up the bar to reduce this.

B. Have the upright telescope bracket combination at about a 45° angle or even more horizontal with respect to the road. More vertical angles are slightly less rigid.

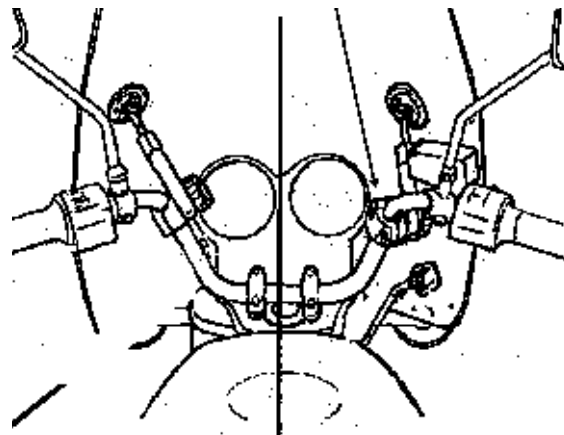

Figure 3.

NOTE: In some cases, such as the ZR1100 and VF750, in order to clear the master cylinder or other obstructions on the handlebars, you will need to reverse the position of the telescope brackets.

7. Examine lower bracket area and select the best location for the fork boss. Figure 4.

INSTALL PIVOT MOUNTS

8. Place 1 piece of double stick tape around handlebar in location of pivot mount. The tape is necessary to avoid rotational slippage on some motorcycles. Attach the pivot mount to the pivot strap with the 1/4 20 bolts (Hex Key). **DO NOT FULLY TIGHTEN AT THIS TIME.** Be sure both sides are symmetrical. Figure 5.

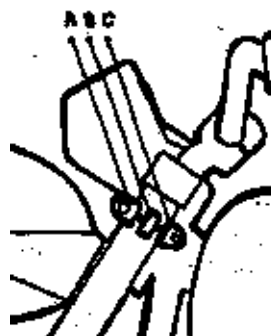

Figure 4.

POSSIBLE FORK BOSS POSITIONS



PLACE PIVOT MOUNT AS CLOSE TO HANDLEBAR AS PRACTICAL.

INSTALL LOWER FORK BOSS

9. Thread fork clamp through fork boss. Install assembly around fork. Do not fully tighten at this time. Position the screw of the clamp facing to the inside or rear of fork.

INSTALL WINDSHIELD

11. Reposition windshield on motorcycle. Engage telescope bracket with pivot mount and secure with QuickSet™ knob.

12. Place wrap-around clamp on lower rod and pinch tight. Push, and thread wind screw through wrap around clamp and then insert and tighten into fork boss. Figure 6.

FINAL ADJUSTMENT

13. Sit on seat in normal riding position with motorcycle off center stand. Grip top of windshield and position screen to achieve the following: Figure 7.

A. No interference with cable or, full turn left and right.

B. Rake angle should approximate fork angle.

NOTE: On some motorcycles it will be necessary to shorten the end of the lower rod. Use a hack saw or a band saw. Apply black, rust inhibiting paint to the end of the rod.

TIGHTEN HARDWARE FULLY IN THE FOLLOWING ORDER:

A. Locking Nuts, wrap with soft paper or cloth to avoid scratches (adjustable wrench).

B. Hex bolts of pivot mounts (hex key).

C. Quickset™ knobs (hand tighten firmly).

D. Lower Fork clamps install to forks (flat blade screwdriver).

Tighten fork clamps after wing screw is tight.



SNAP WRAP AROUND CLAMP AROUND LOWER ROD. INSERT WING SCREW

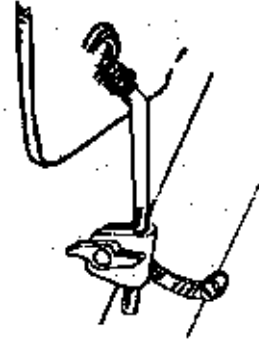

Figure 6.

WRAP LOCKING NUT WITH SOFT PAPER OR CLOTH TO AVOID SCRATCHES.



SUPPORT BRACKET IN PLACE WITH OTHER HAND.

Figure 7.