

Wichtige Montagehinweise:

Kontrollieren Sie wenige Tage nach der Erstmontage den festen Sitz der Crash Balls und danach regelmäßig im Abstand von ca. 3 Monaten. Schrauben bei Bedarf nachziehen, das Anzugsdrehmoment beträgt 10Nm

Anbau vorne rechts

Erst diese Teile endfest montieren und in die Achse schieben!

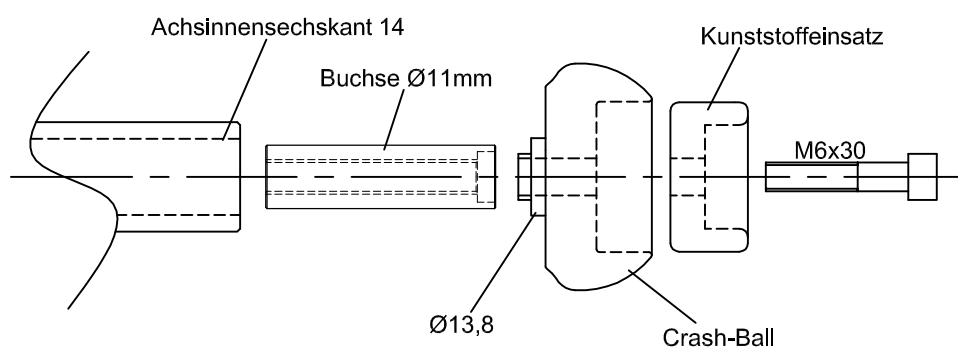

Anbau vorne links

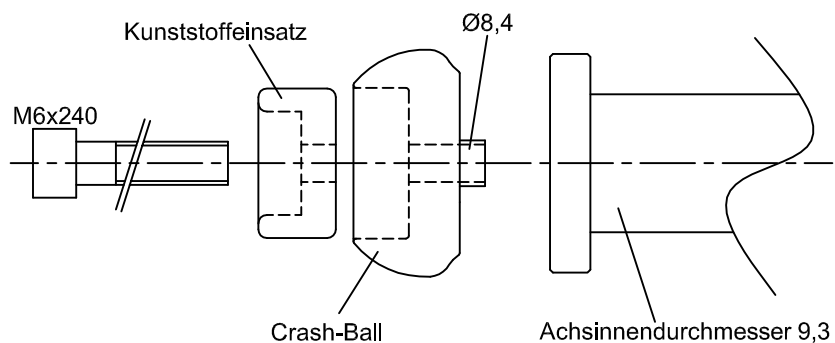

LSL-Motorradtechnik GmbH • D-47809 Krefeld

www.lsl.eu

Rev.00 15.11.13

Fitting instruction Crash Balls for Axle Protection part.-no.: 555Y129..

Important mounting instruction:

Check the Crash Balls for proper fit a few days after first installation, then periodically every 3 month. Tighten them again if necessary. The tightening torque is 10Nm / 7.3lbf ft.

Fitting front, right side

Mount this parts and tighten them, then insert them into the axle!

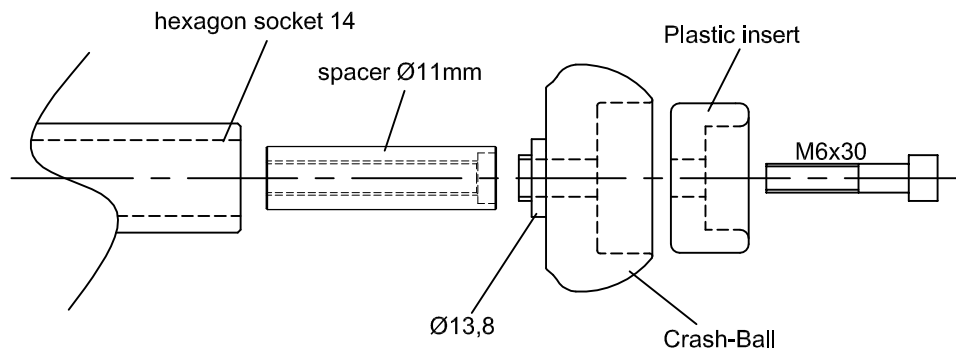

Fitting front, left side

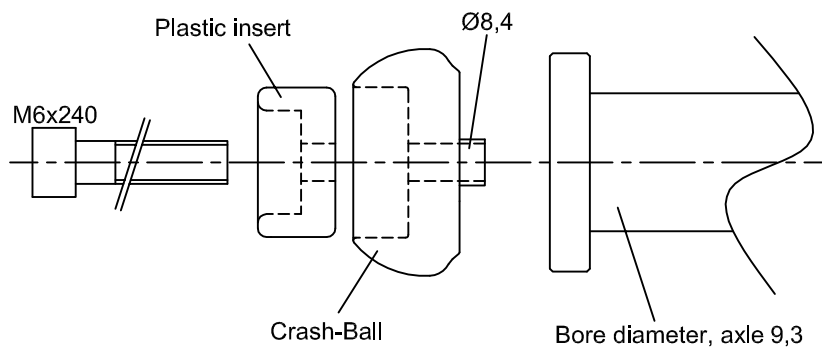

LSL-Motorradtechnik GmbH • D-47809 Krefeld

www.lsl.eu

Rev.00 15.11.13

Instructions de montage pour protecteurs d'axe Crash Ball

N°article: 555Y129..

Important :

Contrôlez le serrage quelques jours après le premier montage, puis régulièrement, tous les trois mois environ. Serrez les vis à un couple de serrage de 10 Nm.

Montage à l'avant droite

Commencez par le montage des pièces avant de les pousser sur l'axe!

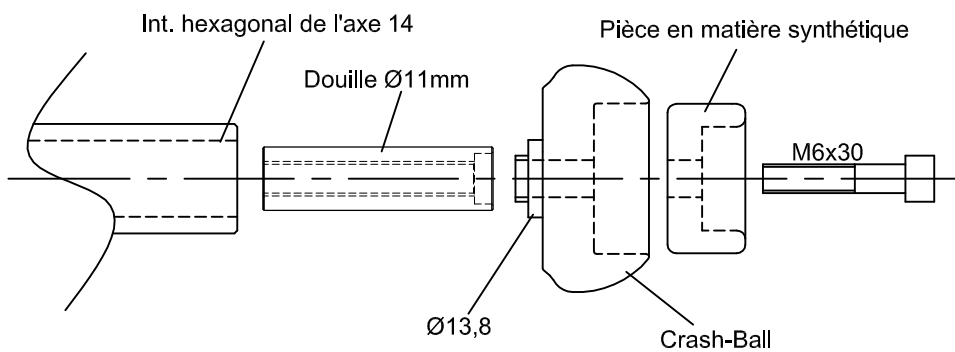

Montage à l'avant gauche

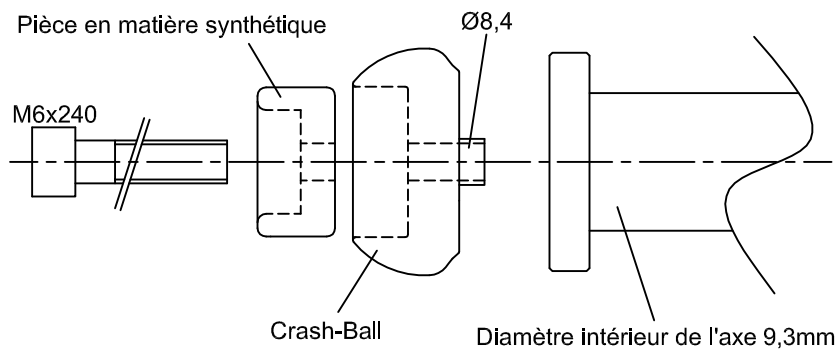

LSL-Motorradtechnik GmbH • D-47809 Krefeld

www.lsl.eu

Rev.00 15.11.13